

PRÁTICA

—EUROPE—

2025 Catalog





WELCOME TO **PRÁTICA**

Prática, founded in 1991, offers cutting-edge equipment for the food preparation market, including an extensive product portfolio in the category of speed ovens. With over 700 employees, including 55 in Research & Development in its fully operational 20.000m² factory located in Minas Gerais, Brazil, where it is the market leader. Additionally, the company has a strong presence in the international market, with branches in the United States, Chile and Germany, and exports its products to more than 50 countries.

At Prática, our purpose is to help our customers prepare high-quality food without waste. We understand the crucial role we play in the chain that begins with fields and crops and ends with providing prepared food to people. With our state-of-the-art technology and integrated product solutions, as well as pre-and post-sales support networks, we truly improve our customers' operations in quality food preparation, productivity, and profitability.

A well-aligned team, driven by strong values and a positive vision for the future, is propelling Prática towards an increasingly prominent position in the world.

PRÁTICA
— EUROPE —

OUR VALUES

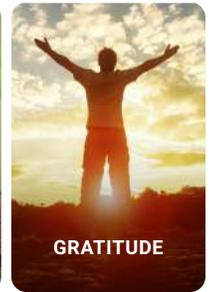
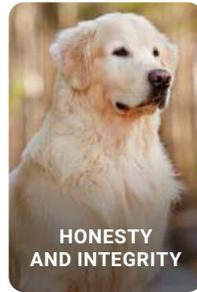
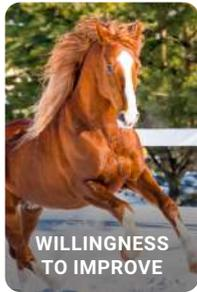

OUR PURPOSE

QUALITY FOOD WITHOUT WASTE



WELL-BEING



PRODUCTIVITY



SUSTAINABILITY

MANUFACTURING PLANT
State of Minas Gerais - Brazil



PRESENT IN OVER 50 COUNTRIES

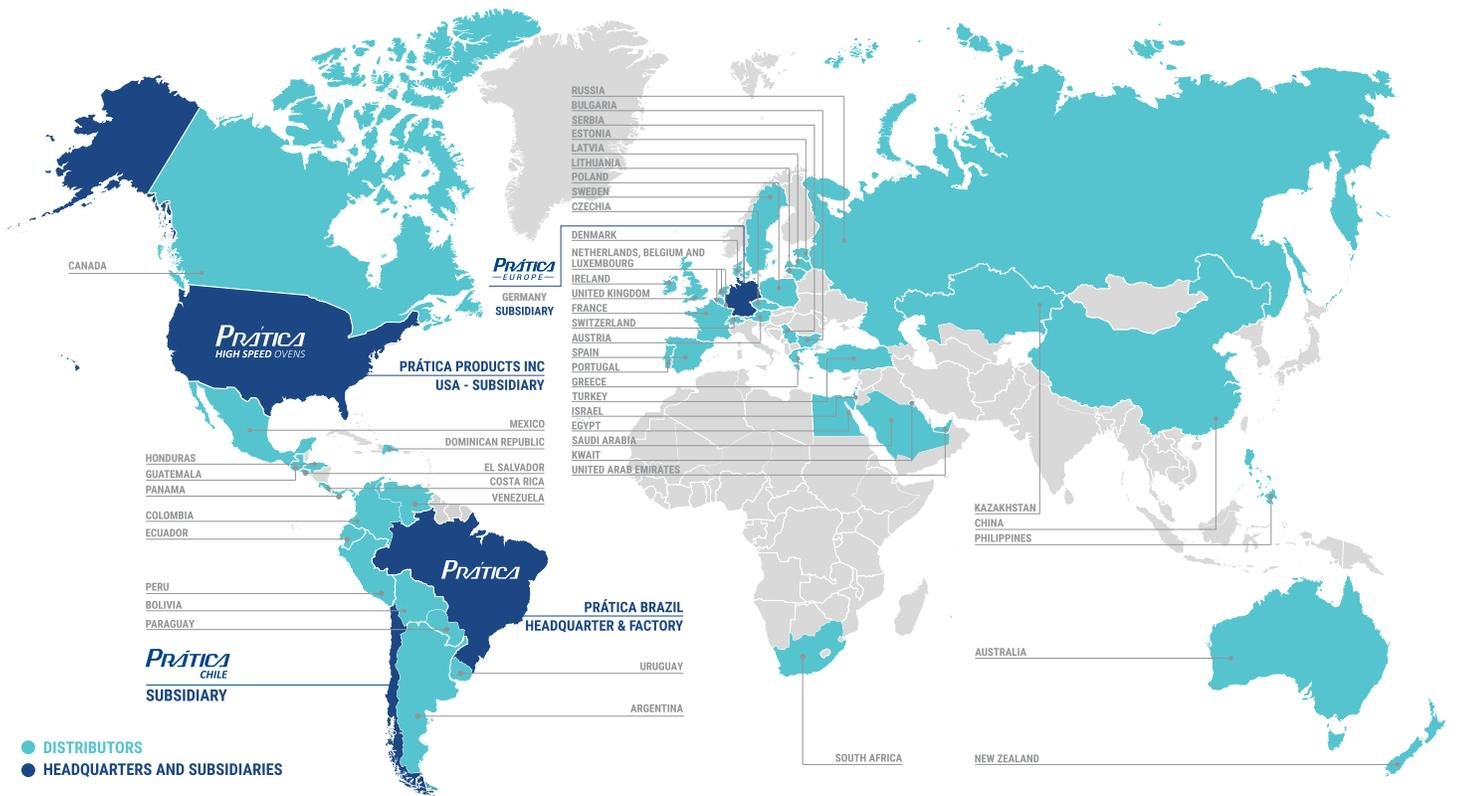

Zoom in to get a better view.

INDEX

- 8** Fit Express
- 10** Fit SM
- 12** Fit XL
- 14** Fit ST
- 18** Forza STi
- 23** Technology
- 28** Accessories
- 32** Miniconvx HP





SPEED OVENS

Prática's speed ovens are ultra-fast, high-performing ovens used for preparing, and finishing, fresh, refrigerated, or frozen foods. Each use results in excellent appearance, crunchiness, and taste.

With cutting edge technology, the ovens work with multiple heat sources, such as, impinged hot air, microwave, and direct radiation. They are equipped with a ventless system through an easily removable catalytic converter and requires no extraction hood for operation, making it easy to clean and maintain.

With a friendly touch screen interface, Prática speed ovens have easy operation and quick preparations, are ideal for service with agility and quality.

PRÁTICA
—EUROPE—



BACK TO MENU



FIT EXPRESS

The Fit Express high-speed oven is designed for efficiently finalizing refrigerated, fresh, or frozen foods, such as breakfast sandwiches, chicken wings, muffins, lasagnas, mac & cheese, sub sandwiches, and other partially prepared dishes. It delivers excellent flavor, appearance, and crispiness. The combination of impinged air and microwaves allows for heating, browning, or toasting foods faster than traditional methods.



FIT EXPRESS BLACK



FIT EXPRESS ORANGE

- Fits on 40cm width countertops and cooks 30cm pizzas.
- User interface: full-color user-friendly touchscreen display. Drag and drop features.
- IOK: Create, edit, and organize groups, recipes, and complete menus directly on the oven or from your computer using Wi-Fi or USB Flash Drive and send them to all connected ovens.
- Multi-language system: Portuguese, English, Spanish, French, German, Polish, Russian, Mandarin, Greek.
- Ventless: no hoods needed.
- The removable catalytic converter allows operators to perform the cleaning without the need for a maintenance service call.
- Secures consistent results: through precise control, even heat distribution, rapid cooking, built-in sensors, and customization options, ensuring uniform and efficient cooking for reliable outcomes.
- Independently adjust microwave power, temperature, and impinged air while programming recipes on the oven.
- No side vents, allowing zero side clearance.
- Elegant & Intuitive: Stores unlimited recipes, with their own steps, settings, icons, or photos.
- Temperatures up to 280°C: The impinged air convection technology combined with microwave capabilities enables users to cook food faster than when using traditional processes.
- Heat insulation: prevents the surrounding area from heating up and keeps the surface cool to the touch.

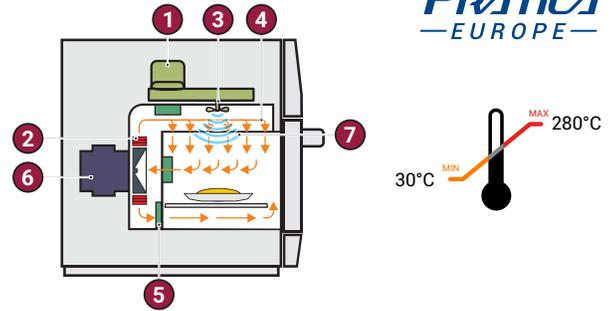

- 1. Magnetron
- 2. Resistance (infrared)
- 3. Stirrer
- 4. Impinged Air
- 5. Catalytic Converter
- 6. Blower Motor
- 7. Microwaves

COOK TIMES

Ham & Cheese Panini	50 sec
Italian Sub	55 sec
Fresh Omelet	1 min 30 sec
Frozen Pizza 30cm	2 min
Steamed Salmon	2 min 30 sec



CERTIFIED
VENTLESS
WITH EASILY REMOVABLE
CATALYTIC CONVERTER.



INCLUDED ACCESSORIES

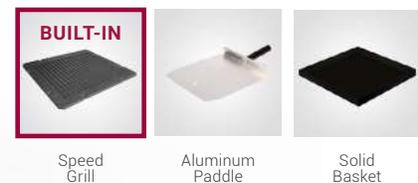

• **1 year warranty** for parts and labor, with the exception of naturally worn items.

FIT EXPRESS DOUBLE MAG											
Region	Voltage (V)	Phases	Freq. (Hz)	Power (kW)	Circuit Breaker (A)	Cable (mm ²)	Socket	Product dimensions (Height x Width x Depth)	Boxed product dimensions (Height x Width x Depth)	Chamber dimensions (Height x Width x Depth)	Clearance (Left / back / right side)
Europe	230	Single	50	6.8	32	3x4	32A(2P+E)	659 x 386 x 693 (mm)	903 x 510 x 897 (mm)	133 x 315 x 308 (mm)	0 / 0 / 0 (mm)
	380	Multi		6.5	16	5x2,5	16A(3P+N+E)				
	400	Multi		6.8	16	5x2,5	16A(3P+N+E)				



FIT SM

S I N G L E M A G

The Fit Express Single Mag high-speed oven is designed for efficiently finalizing refrigerated, or fresh food items, such as breakfast sandwiches, pizzas, sub sandwiches, pastries and more! It delivers excellent flavor, appearance, and crispiness. The combination of impinged air and microwaves allows for heating, browning, or toasting foods faster than traditional methods. The Fit Express SM is not recommended for frozen food.



- Ideal for fresh or refrigerated food items. Not recommended for frozen food.
- Energy efficient: It is designed to be energy-efficient, so you save money on electricity comparing to other models.
- Fits on 40cm width countertops and cooks 30cm pizzas and sandwiches.
- User interface: full-color user-friendly touchscreen display. Drag and drop features.
- IOK: Create, edit, and organize groups, recipes, and complete menus directly on the oven or from your computer using Wi-Fi or USB Flash Drive and send them to all connected ovens.
- Ventless: no hoods needed.
- The removable catalytic converter allows operators to perform the cleaning without the need for a maintenance service call.
- Independently adjust microwave power, temperature, and impinged air while programming recipes on the oven.
- No side vents, allowing zero side clearance.
- Elegant & Intuitive: Stores unlimited recipes, with their own steps, settings, icons, or photos.
- Temperatures up to 280°C: The impinged air convection technology combined with microwave capabilities enables users to cook food faster than when using traditional processes.
- Heat insulation: prevents the surrounding area from heating up and keeps the surface cool to the touch.

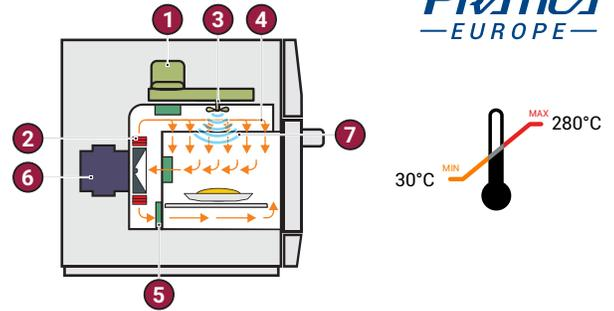

- 1. Magnetron
- 2. Resistance (infrared)
- 3. Stirrer
- 4. Impinged Air
- 5. Catalytic Converter
- 6. Blower Motor
- 7. Microwaves

COOK TIMES

Pastries	25 sec
Sub Sandwiches	40 sec
Hot Dog	50 sec
Paninis	1 min 10 sec



CERTIFIED
VENTLESS
WITH EASILY REMOVABLE
CATALYTIC CONVERTER.



INCLUDED ACCESSORIES

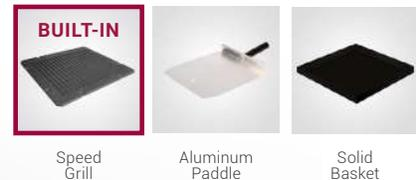

• **1 year warranty** for parts and labor, with the exception of naturally worn items.

FIT EXPRESS SINGLE MAG											
Region	Voltage (V)	Phases	Freq. (Hz)	Power (kW)	Circuit Breaker (A)	Cable (mm ²)	Socket	Product dimensions (Height x Width x Depth)	Boxed product dimensions (Height x Width x Depth)	Chamber dimensions (Height x Width x Depth)	Clearance (Left / back / right side)
Europe	230	Single	50	3	13 16	3x1,5	13A(2P+E) 16A(2P+E)	659 x 386 x 693 (mm) 56kg	903 x 510 x 897 (mm) 75kg	133 x 315 x 308 (mm) 13L	0 / 0 / 0 (mm)



FIT XL

The Fit XL high-speed oven features a 16-inch chamber and is designed to efficiently finalize refrigerated, fresh, or frozen foods, such as breakfast sandwiches, chicken wings, muffins, lasagnas, mac & cheese, sub sandwiches, and other partially prepared dishes. Capable of handling larger portions, it is ideal for medium and large businesses. The FIT XL delivers excellent flavor, appearance, and crispiness. By combining impinged air and microwaves, it heats, browns, and toasts foods faster than traditional methods.



FIT XL BLACK



FIT XL SILVER

- 40cm chamber.
- Capable of handling larger portions, it is ideal for medium and large businesses.
- Stores unlimited recipes with up to 8 steps each, divided into 16 groups.
- USB port for system updates and importing/exporting groups, recipes, and settings.
- Wi-Fi capabilities, enabling remote management for system updates and importing/exporting groups, recipes, and settings via the IOK online platform.
- Adjustable temperature from 30°C to 280°C.
- Independent control of impinged air (high-speed air blast) and microwaves.
- User-friendly touchscreen panel.
- Constructed from stainless steel.
- Certified Ventless – no need for vent hoods. Easy-to-remove catalytic converter for hassle-free cleaning.
- Additional functionalities: Test Mode and Favorites.
- Daily cleaning guide with explanatory videos displayed on the screen, demonstrating the step-by-step process.
- Warranty: one (1) year covering manufacturer defects, part failures, and pre-approved labor, and two (2) years on all the heating elements, magnetrons, and blower motor of the oven.

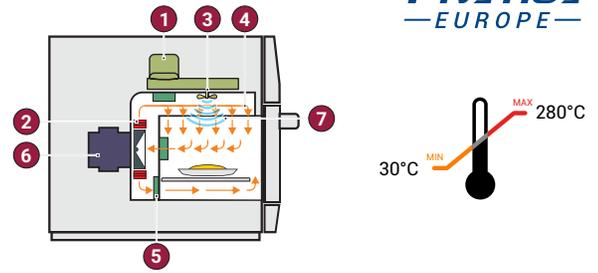

- | | |
|--------------------------|------------------------|
| 1. Magnetron | 5. Catalytic Converter |
| 2. Resistance (infrared) | 6. Blower Motor |
| 3. Stirrer | 7. Microwaves |
| 4. Impinged Air | |

COOK TIMES

Frozen Pizza 40cm	3 min 30 sec
3 Sub Sandwiches	1 min
6 Paninis	1 min 30 sec
Frozen Fries 900g	4 min 30 sec



CERTIFIED
VENTLESS
WITH EASILY REMOVABLE
CATALYTIC CONVERTER.

INCLUDED ACCESSORIES

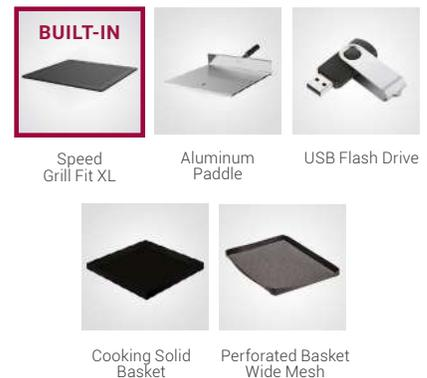

Region	Voltage (V)	Phases	Freq. (Hz)	Power (kW)	Circuit Breaker (A)	Cable (mm ²)	Socket	Product dimensions (Height x Width x Depth)	Boxed product dimensions (Height x Width x Depth)	Chamber dimensions (Height x Width x Depth)	Clearance (Left / back / right side)
Europe	230	Single	50	6.8	32	3x4	32A(2P+E)	658 x 488 x 795 (mm) 82kg	905 x 590 x 960 (mm) 103kg	139 x 417 x 410 (mm) 23.7L	0 / 0 / 0 (mm)
	380	Multi		6.5	16	5x2,5	16A(3P+N+E)				
	400	Multi		6.8	16	5x2,5	16A(3P+N+E)				



FITST

The Fit ST high-speed oven features a 30cm chamber and can be stacked up to two units high. It is designed to efficiently finalize refrigerated, fresh, or frozen foods, such as breakfast sandwiches, chicken wings, muffins, lasagnas, mac & cheese, sub sandwiches, and other partially prepared dishes. Ideal for any business size, the oven delivers excellent flavor, appearance, and crispiness. By combining impinged air and microwaves, it heats, browns, and toasts foods faster than traditional methods.



STACKABLE



BACK TO MENU

- The FIT ST can be stacked up to 2 units (1+1).
- Stores unlimited recipes with up to 8 steps each, divided into 16 groups.
- USB port for system updates and importing/exporting groups, recipes, and settings.
- Wi-Fi capabilities, enabling remote management for system updates and importing/exporting groups, recipes, and settings via the IOK online platform.
- Adjustable temperature from 30°C to 280°C.
- Independent control of impinged air (high-speed air blast) and microwaves.
- User-friendly touchscreen panel.
- Constructed from stainless steel.
- Certified Ventless – no need for vent hoods. Easy-to-remove catalytic converter for hassle-free cleaning.
- Additional functionalities: Test Mode and Favorites.
- Daily cleaning guide with explanatory videos displayed on the screen, demonstrating the step-by-step process.
- Warranty: one (1) year covering manufacturer defects, part failures, and pre-approved labor, and two (2) years on all the heating elements, magnetrons, and blower motor of the oven.

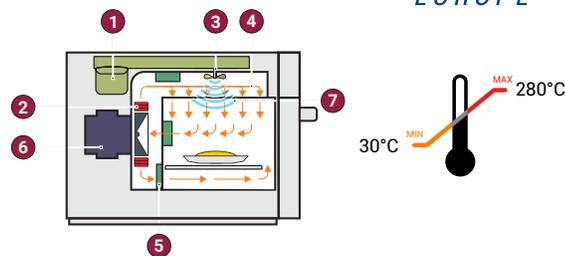

1. Magnetron
2. Resistance (infrared)
3. Stirrer
4. Impinged Air
5. Catalytic Converter
6. Blower Motor
7. Microwaves

COOK TIMES

Ham & Cheese Panini	50 sec
Italian Sub	55 sec
Fresh Omelet	1 min 30 sec
Frozen Pizza 30cm	2 min
Steamed Salmon	2 min 30 sec

CERTIFIED
VENTLESS
WITH EASILY REMOVABLE
CATALYTIC CONVERTER.



INCLUDED ACCESSORIES



FIT ST DOUBLE MAG											
Region	Voltage (V)	Phases	Freq. (Hz)	Power (kW)	Circuit Breaker (A)	Cable (mm ²)	Socket	Product dimensions (Height x Width x Depth)	Boxed product dimensions (Height x Width x Depth)	Chamber dimensions (Height x Width x Depth)	Clearance (Left / back / right side)
Europe	230	Single	50	6.8	32	3x4	32A(2P+E)	425 x 518 x 697 (mm) 72kg	722 x 620 x 825 (mm) 94kg	133 x 315 x 308 (mm) 13L	0 / 0 / 25 (mm)
	380	Multi		6.5	16	5x2,5	16A(3P+N+E)				
	400	Multi		6.8	16	5x2,5	16A(3P+N+E)				

FIT ST SINGLE MAG*											
Region	Voltage (V)	Phases	Freq. (Hz)	Power (kW)	Circuit Breaker (A)	Cable (mm ²)	Socket	Product dimensions (Height x Width x Depth)	Boxed product dimensions (Height x Width x Depth)	Chamber dimensions (Height x Width x Depth)	Clearance (Left / back / right side)
Europe	230	Single	50	3	13 / 16	3x1,5	2P+E / 16A(2P+E)	425 x 518 x 697 (mm) 61kg	722 x 620 x 825 (mm) 83kg	133 x 315 x 308 (mm) 13L	0 / 0 / 25 (mm)

The Fit ST - Single Mag is not recommended for operations with frozen products.

A C C E S S O R Y

PANINI PRESS

FOR **FITST**, **FITSM** AND **FIT EXPRESS** USE ONLY



The Panini Press is an optional accessory for the FIT Express, ideal for making delicious sandwiches and paninis with grill marks.

- Specifically designed for use with the FIT Express, Fit SM and Fit ST.
- It is constructed from aluminum and coated with a non-stick layer.
- Versatility: Accommodate a variety of foods with an opening range of 12mm to 74,6mm between the top and bottom grills.
- Create perfectly pressed, grill-marked paninis, melts, subs, burritos, quesadillas, and more.
- Easy Installation, Use, and Cleaning.
- Comes with an exclusive paddle for sliding food between the top and bottom plates, also ensuring safe opening and closing.
- It is possible to keep the panini press in the chamber, even when cooking other items without grill marks, by placing the basket on top of it.
- Dishwasher safe.

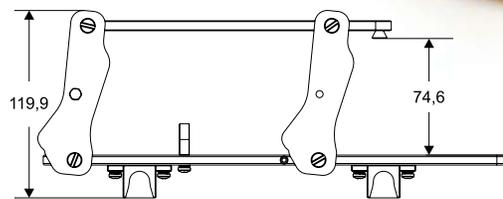
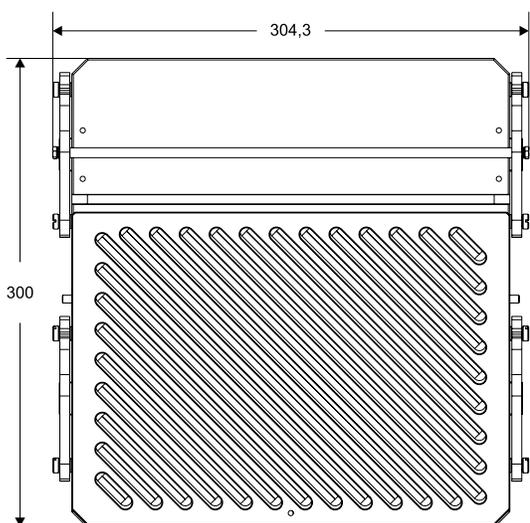

OPEN

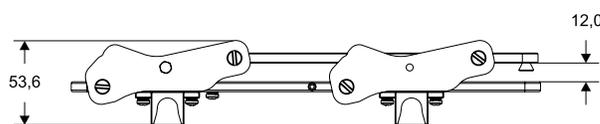

CLOSED



*Not recommended for preparing meats



FORZA STi

Designed to ensure swift and exceptional deliveries, even during peak demands, the Forza StI proves to be an ideal solution for QSR (Quick Service Restaurants) establishments, as well as pizzerias, bakeries, hotels, kiosks, and convenience stores. The production of pizzas, flatbreads, cookies, and more becomes even better with the Forza STi, ensuring superior appearance, flavor, and textures. The combination of impinging air and infrared radiation allows for heating, browning, or toasting foods faster than traditional methods.



STACKABLE



Forza STi



Forza STi Double Stacked

- Secures consistent results: through precise control, even heat distribution, rapid cooking, built-in sensors, and customization options, ensuring uniform and efficient cooking for reliable outcomes.
- Pizzas up to 40cm: fresh, or par-baked dough, thin or thick crust.
- Stackable: can be stacked up to two ovens.
- Each cavity has its own independent controls, allowing the temperature to be set individually, up to 330°C each.
- Elegant & Intuitive: stores unlimited recipes, with their own steps, settings, icons, or photos.
- User interface: full-color user-friendly touchscreen display. Drag and drop features.
- Multi-language system: Portuguese, English, Spanish, French, German, Polish, Russian, Mandarin, Greek.
- IOK: Create, edit, and organize groups, recipes, and complete menus directly on the oven or from your computer using Wi-Fi or USB Flash Drive and send them to all connected ovens.
- Ventless: no hoods needed.
- The removable catalytic converter allows operators to perform the cleaning without the need for a maintenance service call.
- Heat insulation: prevents the surrounding area from heating up and keeps the surface cool to the touch.

Prática
—EUROPE—

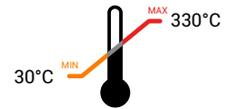
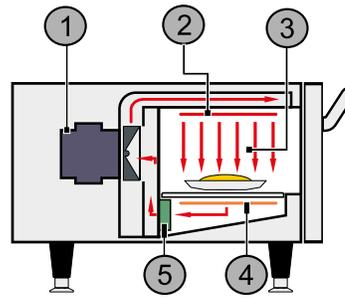

1. Blower Motor
2. Impingement Heater
3. Impinged Air
4. IR heater
5. Catalytic Converter

COOK TIMES

Bruschettas	45 sec
Toasted Sub Sandwich	55 sec
Fresh Dough 40cm Pizza	3 min 30 sec
Half size sheet pan of cookies	10 min
Flatbread Pizza	2 min 15 sec

CERTIFIED
VENTLESS
WITH EASILY REMOVABLE
CATALYTIC CONVERTER.

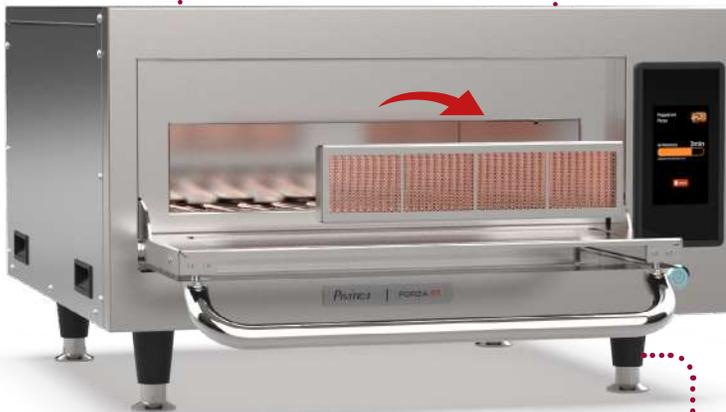

OPTIONAL ADJUSTABLE FEET

[CLICK HERE](#)
LEARN MORE

INCLUDED ACCESSORIES



Aluminum Paddle Door cleaning Tool 2 Pizza Screen 40cm

1 year warranty for parts and labor, with the exception of naturally worn items.

Region	Voltage (V)	Phases	Freq. (Hz)	Power (kW)	Circuit Breaker (A)	Cable (mm ²)	Socket	Product dimensions (Height x Width x Depth)	Boxed product dimensions (Height x Width x Depth)	Chamber dimensions (Height x Width x Depth)	Clearance (Left / back / right side)
Europe	230	Single	50	6.6	32	3x4	32A(2P+E)	Without feet 340 x 705 x 788 (mm) 67kg	640 x 845 x 955 (mm) 86kg	93 x 460 x 435 (mm) 18.6L	0 / 0 / 25 (mm)
								With feet 442 x 705 x 788 (") 67kg			

BACK TO MENU

FORZA STi



BACK TO MENU



Small footprint

34 x 70,5 x 78,8
height x width x depth (cm)



Ventless technology

No need of hoods
for operation



Prepares 40cm pizzas

In 3 min 30 sec



**Temperatures
up to 330°C**

Separate controls for
temperature, and air
impingement, bottom
IR element of the chamber



**Double glass door
& lighted cavity**

See cooking
progress as the
oven is working



**Energy
efficient**

low energy
consumption



Stainless steel

Exterior & interior



**Available with
10cm legs optional**

(or without)

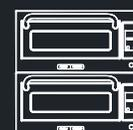

Stackable

Can be stacked in
up to two ovens



Each cavity has its own controls

Can be used independent of the other



BACK TO MENU



GET IT READY in 2 taps!



Full color user-friendly touchscreen display

ELEGANT AND INTUITIVE

Our ovens store unlimited recipes, with their own steps, settings, icons, or photos.

SIMPLE AND OPTIMIZED

A fresh spin on providing a great user interface while simplifying the basic oven operations for the end user.



FEATURES



Wi-Fi connectivity



Multi-language system
(Portuguese, English, Spanish, French, German, Polish, Russian, Mandarin, Greek)



Photo library for recipes



Cleaning guide video with instructions

BACK TO MENU

USER-FRIENDLY FEATURES

Available in all Prática's high-speed oven models

REMOVABLE CATALYTIC CONVERTER



Easy access and removal of the catalytic converter.

REMOVABLE AIR FILTER



Designed for simple cleaning and maintenance.

MINIMAL CLEARANCE

Advance cooling design eliminates side vents and louvers allowing minimal to zero side clearance.

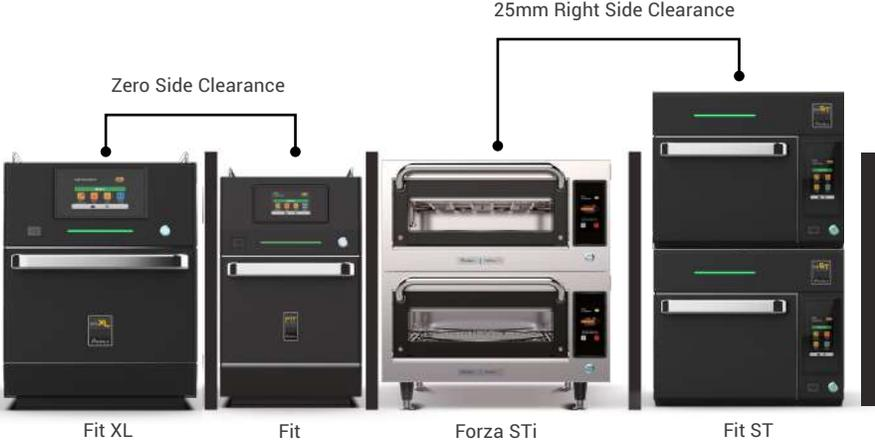

i

Rear clearances are automatically set with factory-installed bumpers.

NO HOODS NEEDED FOR OPERATION!

The Catalytic Converter turns grease-laden vapor into water, allowing the oven to operate with no need for exhaust hoods.*

The Catalytic Converter is removable, allowing operators to perform the cleaning without the need for a maintenance service call.

All Prática's high-speed ovens have been tested and passed EPA202, allowing them to be certified as non-grease emitting appliances.

*The high-speed ovens can't be used to cook foods classified as 'raw fatty proteins', such as bone-in, skin-on chicken, raw bacon, raw hamburger, etc. Trying to do so can damage the catalytic converter.

CERTIFICATIONS





PRÁTICA'S SMART HIGH-SPEED OVENS THE FUTURE OF COOKING

IOK is the connectivity solution for you to remotely manage, via Wi-Fi, recipes and data from your Prática Oven operation.

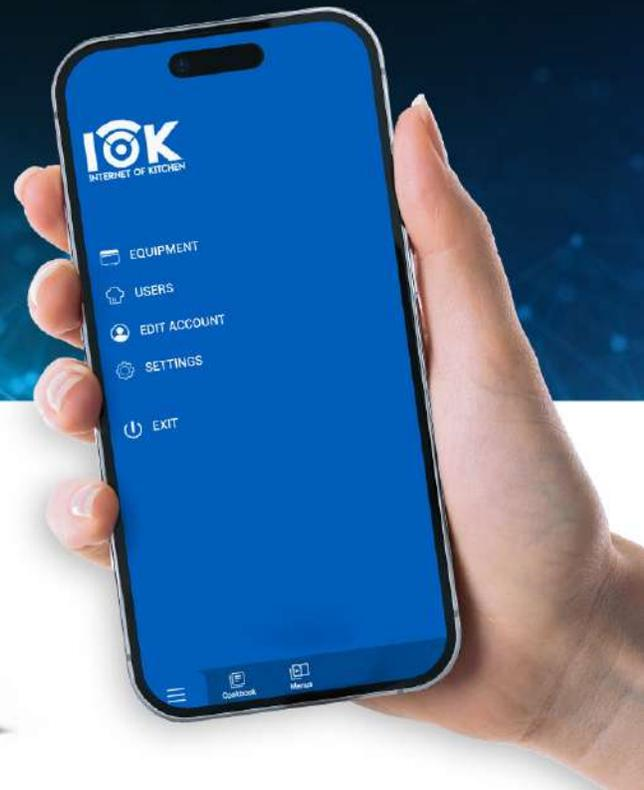

**MANAGE GROUPS
AND RECIPES FROM
YOUR COMPUTER**

Create, edit, remove, and distribute groups and recipes from the computer to all compatible ovens.



**CUSTOMIZE THE
DISPLAY IMAGE OF
RECIPES**

Illustrate recipes with real images of your products.



**RECEIVE SOFTWARE
UPDATES**

Always count on system improvements for free, from small adjustments to major updates (such as a new interface or function, for example).

PRÁTICA IOK USES YOUR WI-FI TO ALLOW FOR SEAMLESS MANAGEMENT OF EQUIPMENT ACROSS MULTIPLE LOCATIONS

Standardize your production and keep track of your ovens even when you are out of your kitchen.



All our touchscreen models now come with the IOK.



When using the IOK it allows you to manage your equipment from anywhere, you can monitor and access IOK from anywhere, PC, MAC, mobile, or tablet



Manage all your ovens and menus from one place.



Create, edit and organize groups, recipes, and complete menus directly on the oven or from your computer and send to all connected ovens.



Customize the recipe icons with photos of your own dishes.



The IOK helps with the consistency of your recipe programming which allows your menu and recipes to be consistent from start to finish.



Obtain the newest updates on your IOK features, interface, and display configuration directly to your machines- no matter the location



Access the exclusive Cookbook with complete recipe suggestions created by Prática's Chefs.



Get customer support via chat using the IOK platform.



[LEARN MORE](#)



[BACK TO MENU](#)

Panini Press

Compatibility: Fit Express / Fit SM / Fit ST



Speed Grill

Compatibility: Fit Express / FIT SM / FIT ST / FIT XL



Solid Basket

Compatibility: Fit Express / FIT SM / FIT ST / FIT XL



Perforated Basket

Compatibility: Fit Express / FIT SM / FIT ST / FIT XL



Pizza Screen

Compatibility: Forza STi



Wave Perforated Basket

Compatibility: Fit Express / FIT SM / FIT ST / FIT XL

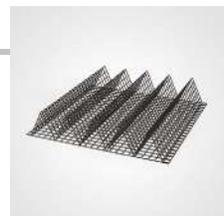

Oven Rack

Compatibility: Forza STi



Aluminum Paddle

Compatibility: Fit Express / FIT SM / FIT ST / FIT XL



Aluminum Paddle Forza STi

Compatibility: Forza STi



Glass Cleaning Tool

Compatibility: Forza STi



Air Inlet Filter - Right Side

Compatibility: Forza STi



Catalytic Converter

Compatibility: Forza STi



Catalytic Converter

Compatibility: Fit Express / Fit SM / Fit ST





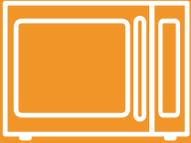

CONVECTION OVENS

Prática's bakery ovens are made to achieve productivity, agility, and quality for baking perfectly uniformed bread and pâtisserie products.

Compact ovens easy to install in the production area or visible to the customer on the shop floor.

User-friendly controls and robust all-stainless steel construction.

PRÁTICA
—EUROPE—



MINICONVX HP

For bakeries, cafes, snack bars, convenience stores and restaurant support and facilities that are meant to serve at all times.

CLICK HERE
 LEARN MORE



Capacity:
4 baking sheets
46 x 33cm

AVAILABLE COLORS

**MINICONVX HP
BLACK**



**MINICONVX HP
STAINLESS STEEL**



 BACK TO MENU

- Stores 100 recipes with up to 4 steps each, plus a preheating step;
- USB connection for importing and exporting recipes;
- Stainless steel and black version;
- Adjustable temperature from 30°C to 250°C;
- Made of stainless steel;
- Heating by shielded resistors;
- Steam generated by water injection at the start of the step;
- Forced air convection system with air circulation by high-performance turbine, with a reversal system;
- Function: Convection Off for turbine stop;
- Chamber lighting;
- Double tempered and foldable door allowing easy cleaning;
- Stackable : maximum 1 equipment (1 + 1);
- Efficient use of energy;

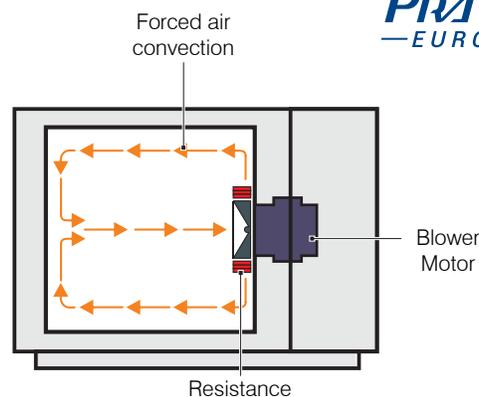

INCLUDED ACCESSORIES

- Four Perforated Baking Sheets 33cmx46cm.

OPTIONAL ITEMS

- Flat baking tray 46cm x 33cm;
- Perforated baking tray 46cm x 33cm;
- Stand;
- Water filter;
- Teflon Coated Flat baking tray 46cm x 33cm;
- Teflon Coated Perforated baking tray 46cm x 33cm;

Side opening door

Facilitates loading and unloading of products.

Door LED lighting

Better visualization of food cooking.

Folding double glass

In addition to providing thermal comfort to the environment, it also makes cleaning easier.



 • **1 year warranty** for parts and labor, with the exception of naturally worn items.

Model	Voltage (V)	Phases	Freq. (Hz)	Power (kW)	Circuit Breaker (A)	Cable (mm ²)	Socket	Product Dimensions (Height x Width x Depth)	Packaged Product Dimensions (Height x Width x Depth)
Miniconvx HP Prog.	220 230	1	50/60	3,2 3,4	16	3x2,5	16A (2P+E)	453x631x638 (mm) 38kg	510x700x760 (mm) 44kg

Check if the product is available with the appropriate voltage and frequency for your region.



Prática and REPA: working together across Europe.

Prática is partnering with REPA in Europe to provide you with speed and ease spare parts shopping.

REPA manages Prática parts programme with 100% original spares and the largest inventory of in-stock parts worldwide. REPA's warehouses ensure immediate availability of a vast selection of spare parts and consumables for all industries at your fingertips while collaborating with top-notch freight forwarders.

Prática and REPA understand how crucial it is to keep your business running smoothly, and we're committed to supporting your operations by ensuring your equipment always performs at its best

REPA is the leading European spare parts distributor for foodservice equipment, coffee, vending machines and household appliances and is a trusted partner to equipment manufacturers. Since 2022 REPA is a division of Parts Town Unlimited, the global leader in high-tech distribution of mission-critical equipment replacement parts, related products and services for the foodservice, residential appliance and HVAC industries.

With a state-of-the-art webshops, high stock availability, highly innovative logistic centers that assure the fastest delivery of spare parts in the industry, REPA provides every customer with the right part, at the right time, everywhere.

www.repagroup.com

 **REPA**
A Parts Town unlimited Company



 REPA

PA

 REPA



www.praticabr.com/en
contact@praticabr.com