

Prática

ACCESSORY
ACCESORIO | ACESSÓRIO

PANINI PRESS



EXCLUSIVO PARA USO CON FIT EXPRESS
FOR
FIT
EXPRESS
USE ONLY
EXCLUSIVO PARA FIT EXPRESS

QUICK USER GUIDE



INDEX

- 4 Included items
- 5 Specs
- 6 How to install
- 8 Cleaning guide

The Panini Press is an optional accessory for the FIT Express, ideal for making delicious sandwiches and paninis with grill marks.

- Versatility: accommodate a variety of foods with an opening range of 0.4" to 2.9" between the top and bottom grills;
- Achieve professional-looking grill marks effortlessly;
- High-Quality Non-Stick Grates: no oil needed;
- Not recommended for preparing meats;
- Exclusively use the Panini Press paddle.

INCLUDED ITEMS



The dual hinge on each side ensures the grill's weight is evenly distributed on the food, guaranteeing a consistently uniform press.

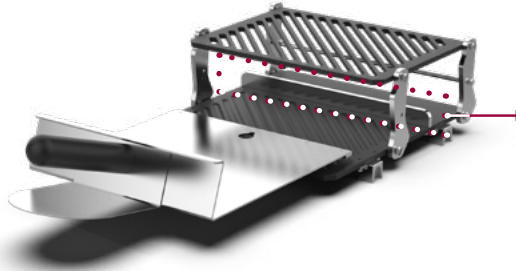

Our Panini Press is thoughtfully designed with a convenient “stop” on the bottom grill, serving as a protective barrier. This feature prevents the food from coming into contact with the catalytic converter at the back of the oven when you’re removing it.

SPECS

The Panini Press is crafted from aluminum and features a non-stick coating.

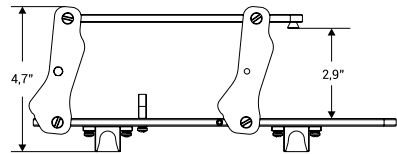
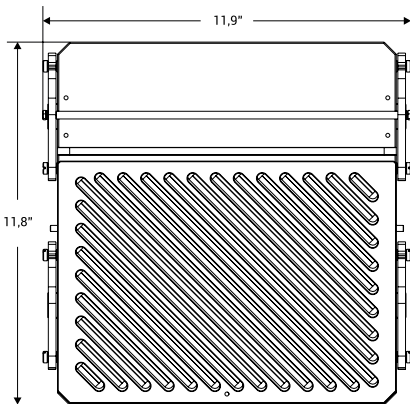

OPEN

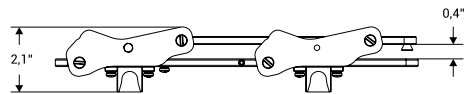

CLOSED

WATCH THE VIDEO



HOW TO INSTALL



CAUTION: Do not install or uninstall it while hot. Do not remove the speed grill or install the Panini Press with the oven on. If it was on, wait for it to cool down first. Touching them while hot may result in severe burns.

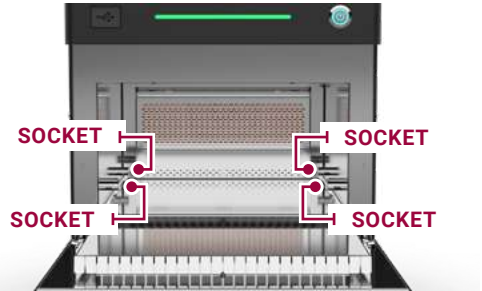

Place the accessory's fitting into the oven's socket following the steps bellow. The Panini Press latches into existing pegs inside the oven.



1 Remove the Speed Grill.

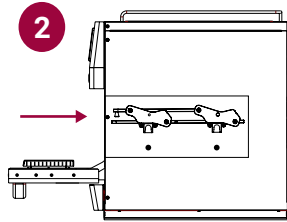

2 Place the Panini Press accessory inside the FIT Express chamber, ensuring the fitting matches the oven's socket. Lower the accessory until it securely latches onto the existing pegs inside the oven. That's it! Your installation is complete.

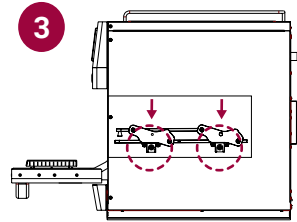

It is possible to use the FIT Express to prepare other food items even with the panini press inside the chamber. To do so, close the panini press, place the basket on top of it, and proceed with the recipe. Cooking results may vary when using the panini press in the chamber compared to not having it inside, so test it and see if any setting adjustments are necessary.

CAUTION: Do not use metallic accessories inside the oven. Use only the FIT Express approved safe accessories for optimal performance and safety.

Follow these steps to place food into the accessory:

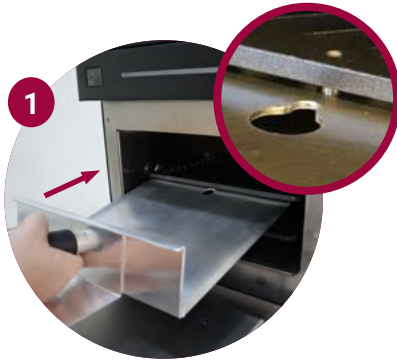

1
Fit the top grill pin into the front slot of the paddle and lift it.



2
Place the food between the grills.



3
Lower the top grill using the front hole in the paddle.



4
After lowering the top grill, close the oven door.

5 Start the recipe ▶

CLEANING GUIDE

To sanitize the Panini Press, follow the steps below:

1



If the oven is hot, access the **Daily Cleaning** function in the main menu and wait for the oven to cool down.

2



Remove the Panini Press from the oven and place it in a sink.

3



Clean it with water and mild detergent, using a non-scratch scrub pad.

4



For persistent stains, utilize the Oven Cleaner and let it soak for up to 10 minutes.

5



Rinse the Panini Press and reinstall it in the oven.



DISHWASHER SAFE



You may use the Oven Cleaner to clean the Panini Press*.

* Don't use the Oven Protector on the Panini Press.